

profometer®

The all-in-one solution for rebar assessment and corrosion analysis



ASTM DIN BS SN DGZFP SIA UNI JGJ/T JSCE



Interactive

Full flexibility

- ✓ Upgrade anytime between cover meter and corrosion analysis instruments
- ✓ Easily switch the probes of the combined instrument
- ✓ New technologies will be added to further increase application range

High productivity

- ✓ Easy and immediate data interpretation with 2D grid and statistical views
- ✓ Dual-core processor for fast data acquisition
- ✓ Dedicated software for efficient custom reporting

User friendliness

- ✓ Profometer touchscreen with illustrative display and assisted workflow
- ✓ On-site post processing of the measured data
- ✓ Rugged housing for harsh environments



Profometer Corrosion interface box
Ready to connect half-cell electrodes to your Profometer unit

profometer®

Speed-up your measuring and reporting!

Profometer 6 Cover Meters

- ✓ Advanced cover meters and rebar locators based on the eddy current pulse induction principle
- ✓ Assisted scan of any surface regardless of its size and geometry
- ✓ Universal probe and detachable cart with wireless path measuring system
- ✓ Complies with international standards BS, DIN, DGZfP, SN, SS, DBV



Profometer Corrosion

- ✓ Most versatile half-cell potential solution
- ✓ Proceq's unique wheel electrodes allow the fastest and most efficient on site testing
- ✓ Compatible with existing Canin and most third party electrodes
- ✓ Complies with international standards ASTM, RILEM, DGZfP, SIA, UNI, JGJ/T, JSCE



[Find out more](#)

[Find out more](#)

Profometer® Touchscreen Universal

Proceq – History of Innovation since 1954

Proceq SA of Switzerland, founded in 1954, is a leading manufacturer of the highest quality portable instruments for non-destructive testing of materials. The popular Original Schmidt concrete test hammer, the patented SilverSchmidt (Q-value) and the Carboteq are just an excerpt of Proceq's proud inventions.



Revolutionary Profometer Touchscreen

As direct successors to the Profometer 5+ and Canin+ models, the **Profometer 6 instruments** continue the successful tradition that began 40 years ago representing the sixth Profometer generation.

In its current version the Profometer brand extends its features to cover additional methodologies related to the testing of reinforcement steel, incorporating both rebar assessment and corrosion analysis functionalities, thus replacing the world renowned Canin instrument for corrosion.

- ✓ Housing specially designed to be used on-site in harsh environments, including carrying strap, integrated stand and sunshield cover
- ✓ High resolution colour touchscreen allowing best possible measuring and analysis of the data for an entire working day (battery lifetime >8h)
- ✓ Dual core processor supporting diverse communication and peripheral interfaces
- ✓ Future proof investment through direct upgrade possibilities to upcoming Profometer products

	Profometer 6 Cover Meters			Profometer Corrosion
	Profometer 600	Profometer 630	Profometer 650	
	For safe drilling, coring and cutting, conformity check of concrete cover, fire resistance assessment and rebar assessment on unknown structures			For corrosion analysis
Rebar Location				
Cover Measurement				①
Diameter Estimation				
Single-Line Scan				
Multi-Line Scan	③			① + ③
Area Scan				
Cross-Line Scan	③	③		① + ③
Corrosion Potential	②	②	②	

Functionality

- ① ② Upgrade kits available (attachable hardware)
- ③ Software upgrades available (activation key)

See how easy you can upgrade your instrument

Profometer 600 Overview

Profometer 600 is the ideal instrument for contractors who need to avoid damages to the reinforcement steel when drilling, coring or cutting. It additionally covers the needs of inspection engineers to locate rebars and to assess concrete cover values and rebar sizes for spot checks.

Locate Mode

With the Locate Mode you can precisely detect the rebar location and direction as well as measure the cover and the rebar diameter.

- ✓ Visual assistance for speed and signal strength control
- ✓ Settings directly accessible on the measurement screen
- ✓ Spot Probe specially for areas with congested rebar arrangements
- ✓ Automatically detects inclined rebars

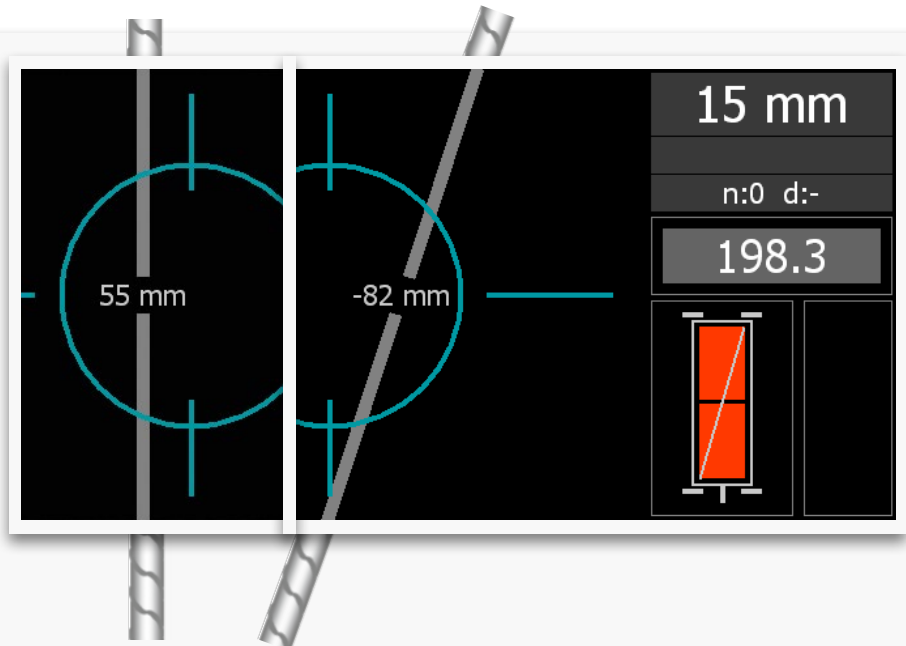

Statistics & Snapshot Views

The statistics and snapshot views allow comprehensive review of the measured data directly on the screen.

The statistics view presents a graphical overview of the distribution of cover measurements. The snapshot view shows cover for each rebar with the diameter displayed as a number.

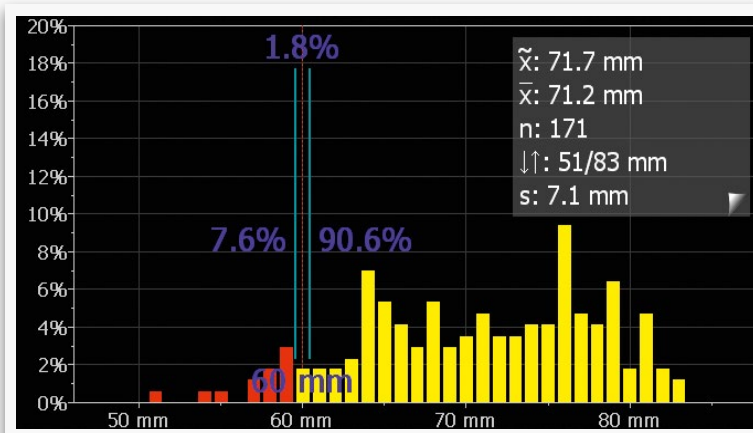

Snapshot view

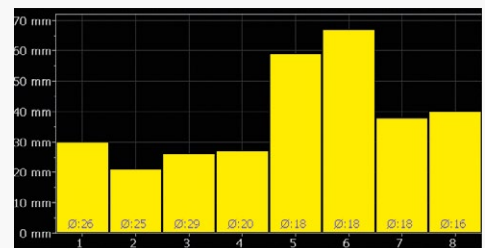

- ✓ Graphical display of measured values and minimum cover set
- ✓ Easy inspection of the measured values directly on the screen
- ✓ Change settings before and after storage
- ✓ Reopen stored files to continue measurements
- ✓ Export the data to a PC via the Profometer-Link software

Profometer® 630

Advanced Scan Cover Meter

Profometer 630 Overview

The sophisticated Profometer 630 further enhances the application range of the Profometer 600 with the Single-Line, Multi-Line and Area Scan Modes and an extensive choice of statistical views, increasing productivity for civil engineers and inspection companies in charge of assessing the conformity of concrete cover of a new structure (quality check and fire resistance assessment) or dealing with corrosion analysis on large elements.

Single-Line Scan

Linear scan of the cover across the first layer of rebars over a long distance, with or without diameter measurement.

- ✓ Measuring over long distances
- ✓ Signal curve allows the user to manually verify and confirm the rebar position delivering an improved resolution
- ✓ Zoom in to scale according to your needs
- ✓ Display with cover curve or signal strength curve

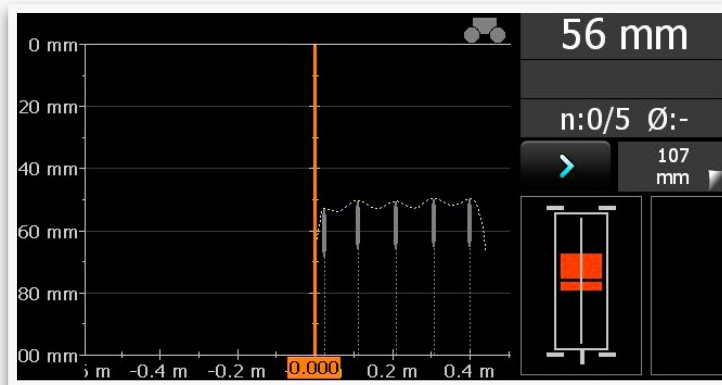

Red color for easy identification of minimum cover violation

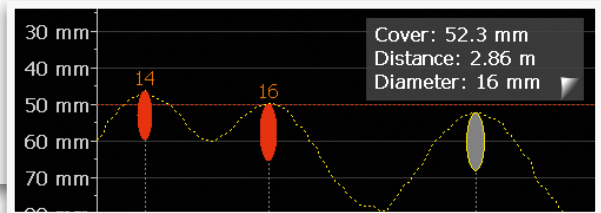

Multi-Line Scan

Multiple linear scans across the first layer of rebars over a rectangular area. Cover, diameter and signal strength spectrum are shown in one view. Each line can be viewed individually in the Single-Line View.

- ✓ Color classification depending on cover and rebar diameter settings
- ✓ Signal strength spectrum for further evaluation

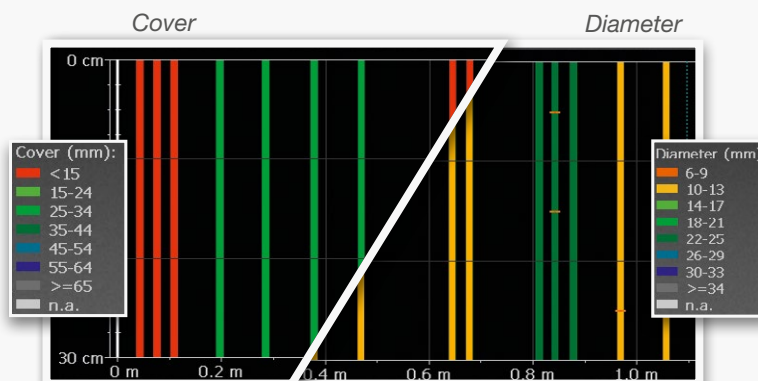

Signal strength spectrum

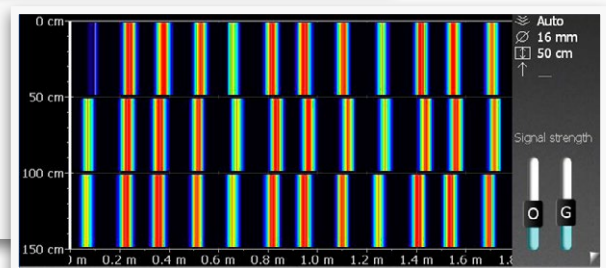

Profometer® 630

Advanced Scan Cover Meter

Area Scan

The grid display of the Area Scan Mode allows a simplified view of the measured cover data.

It is best suited for a combination with potential field measurements.

- ✓ Individual grid size can be selected
- ✓ Use in combination with Profometer Corrosion half-cell potential measurements for corrosion analysis

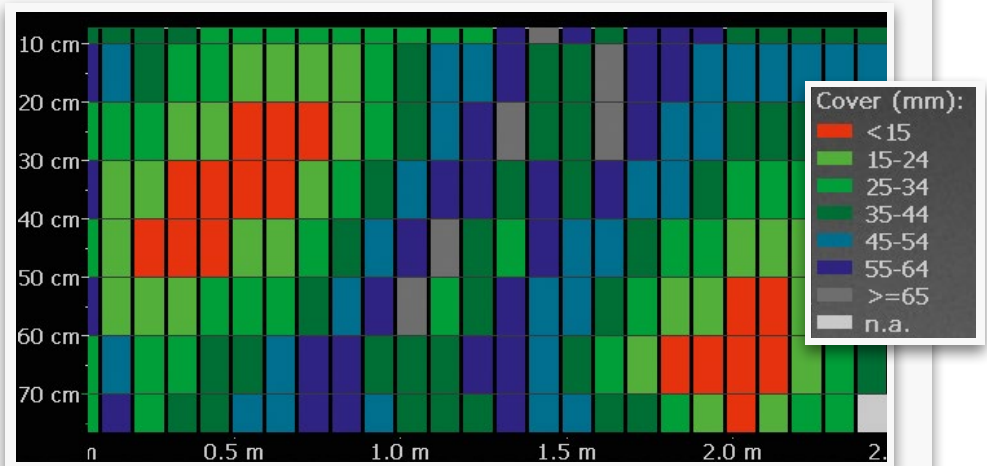

Use the Multi-Line and Area Scan for:

- » Retaining walls
- » Concrete slab soffits
- » Bridge slabs
- » Reinforced walls and slabs



Special statistic view according to DBV*

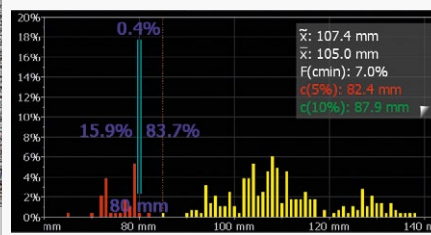

*German Concrete and Construction Association

Profometer® 650

Advanced Cross-Scan Cover Meter

Profometer 650 Overview

The Profometer 650 extends the features of the Profometer 630 further still with the unique Cross-Line Scan measuring mode and analysis functions. Full reporting features available, as required on large investigation campaigns where a comprehensive report is to be delivered to the client.

Cross-Line Scan

The 2D Cross-Line Scan extends the Multi-Line Scan with the special functionality of combining scans in the X- and Y-directions.

- ✓ Measuring the rebars of the first and second layer typically arranged in a rectangular mesh
- ✓ The signal strength spectrum can be seen in addition to the cover and diameter

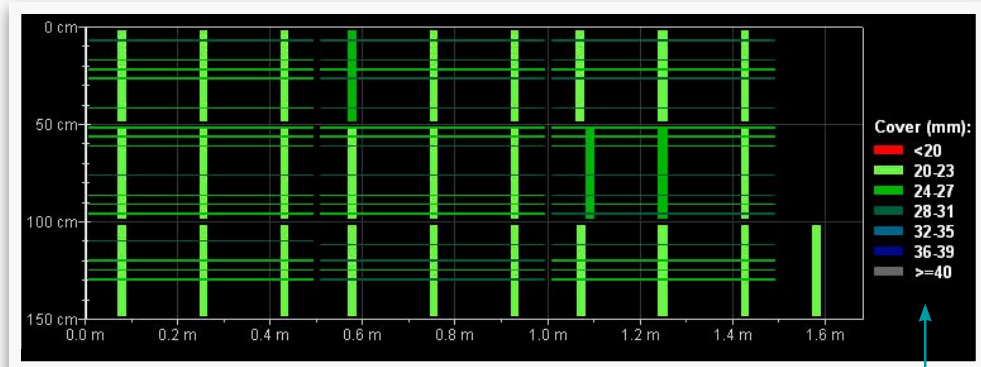

Tap on the screen to switch between Cover, Diameter and Signal Strength View

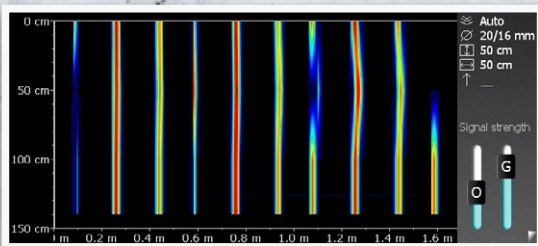
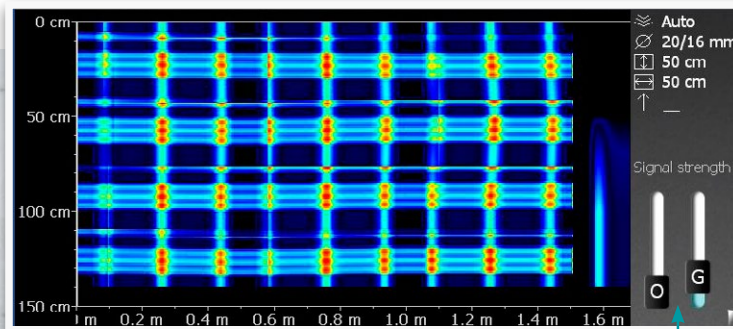

By changing the Offset- and Gain-slider positions the signal strength range and resolution can be set and accordingly shown in a color spectrum, for example to display the first layer of rebars.



Profometer® Cover Meter

Measuring Range

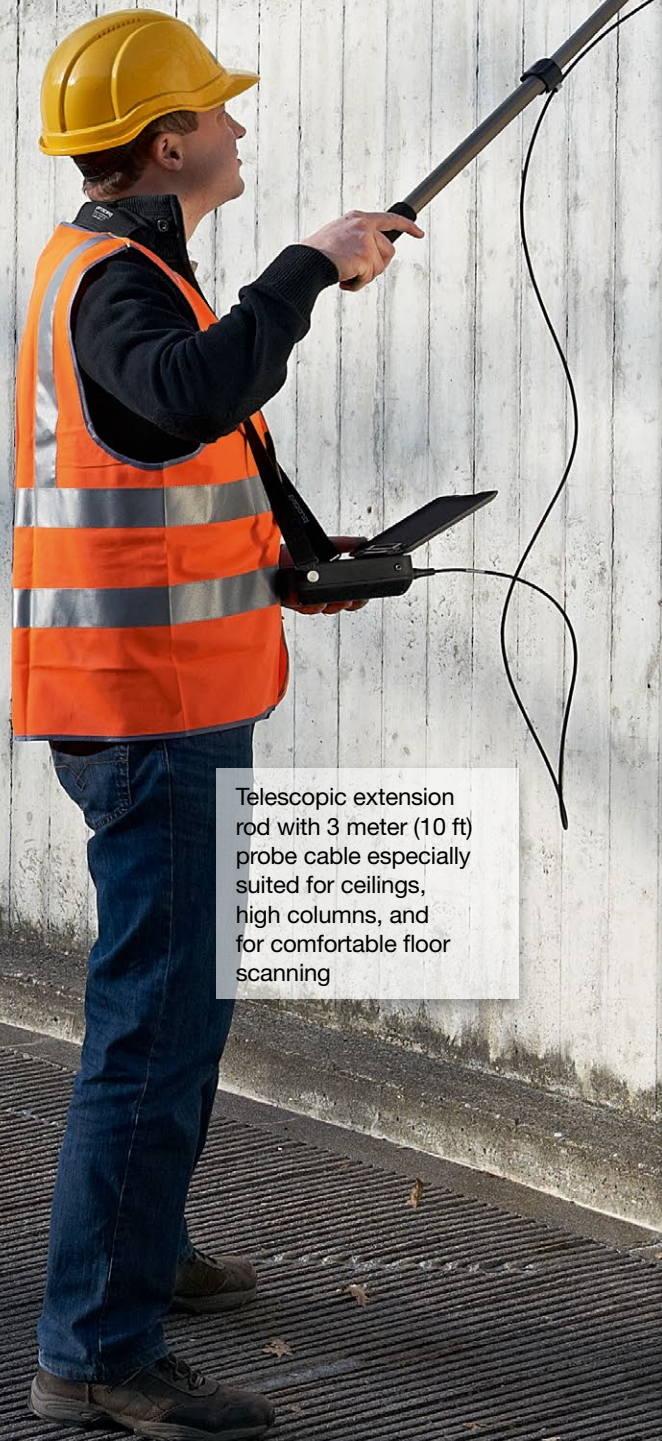

Telescopic extension rod with 3 meter (10 ft) probe cable especially suited for ceilings, high columns, and for comfortable floor scanning

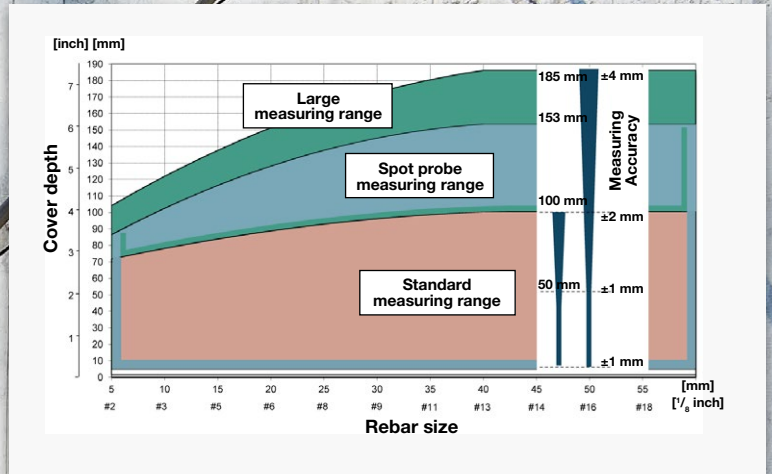

Unsurpassed Resolution

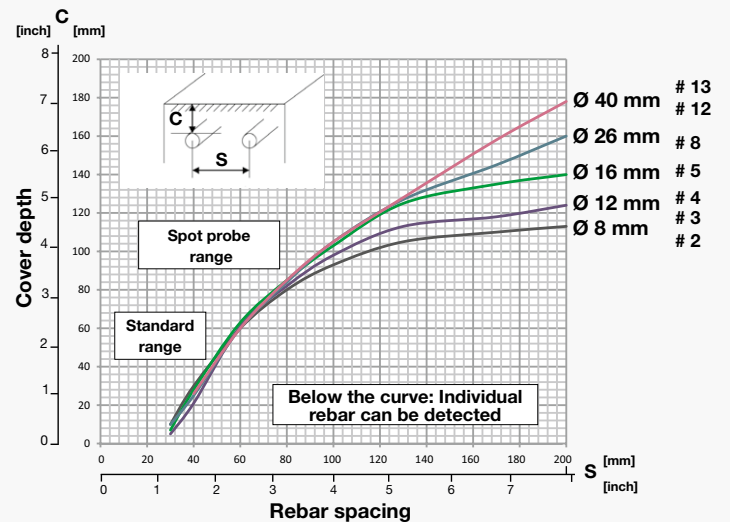

The Technology

The Profometer 6 instruments use **eddy current pulse induction technology** to detect rebars. Multiple coil arrangements in the probe are periodically charged by current pulses and thus generate a magnetic field.

On the surface of any electrically conductive material which is in the magnetic field eddy currents are produced. They induce a magnetic field in the opposite direction. The resulting change in voltage can be utilized for the measurement.

Advanced signal processing allows localization of a rebar, determination of the cover and estimation of the rebar diameter. This method is unaffected by all non conductive materials such as concrete, wood, plastics, bricks etc.

However any kind of conductive materials within the magnetic field will have an influence on the measurement.

Profometer® Corrosion

Corrosion Analysis Instrument

The Technology

The half-cell method is used to identify active corrosion of re-bars based on the electro chemical properties of reinforced concrete. **All the Proceq electrodes (rod or wheel) are based on a Copper / Copper Sulphate (Cu/CuSO₄) half-cell.** However specific applications or customer preferences sometimes require different reference electrodes. This is why the Profometer Corrosion voltage input range allows also the connection of Silver / Silver Chloride (Ag/AgCl) electrodes or Saturated Calomel (Hg/Hg₂Cl₂) reference electrode. **The standard cable supplied with the Proceq rod electrode can be easily connected to most third party rod electrodes allowing the full compatibility of the system.**



The detection of the hot spots where active corrosion begins involves the measuring of the localized negative values of the half-cell potential (i.e. corrosion potential). When using a rod electrode the user has to define a grid fine enough not to

miss any local negative peak, while the use of a wheel electrode on the new Profometer Corrosion ensures a new level of accuracy. **The wheel system is fast enough to measure the electrical potential continuously along its linear paths, ensuring the most negative measured value will always be recognized and stored with its associated location.**

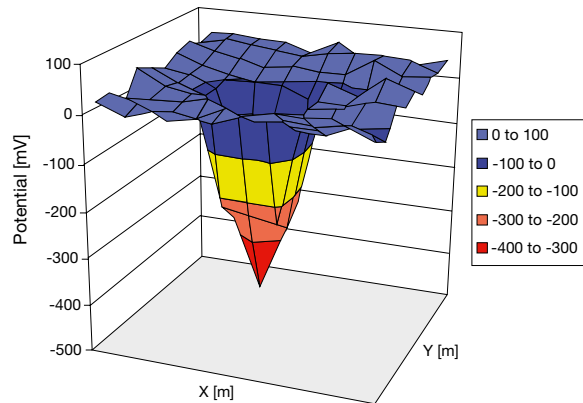

The electrical potential distribution over a corroding area can be represented as a “funnel” centered on the anode, whose shape and extent is defined by the actual ongoing corrosion as well as by the concrete electrical resistivity

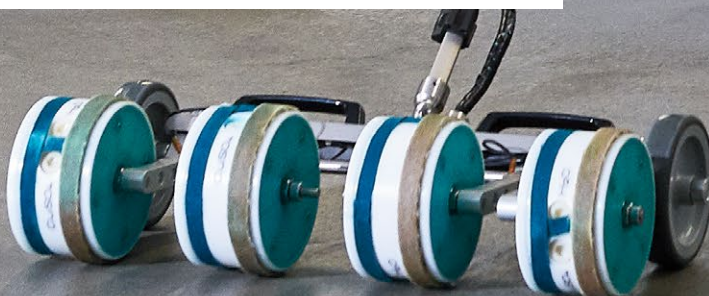

Profometer® Corrosion Corrosion Analysis Instrument

Profometer Corrosion Overview

As the direct successor to the Canin, the Profometer Corrosion represents the most advanced corrosion instrument in the market based on the half-cell method. In addition to the basic rod electrode, the use of Proceq's unique one and four wheel electrodes enables the highest on site productivity on large areas.

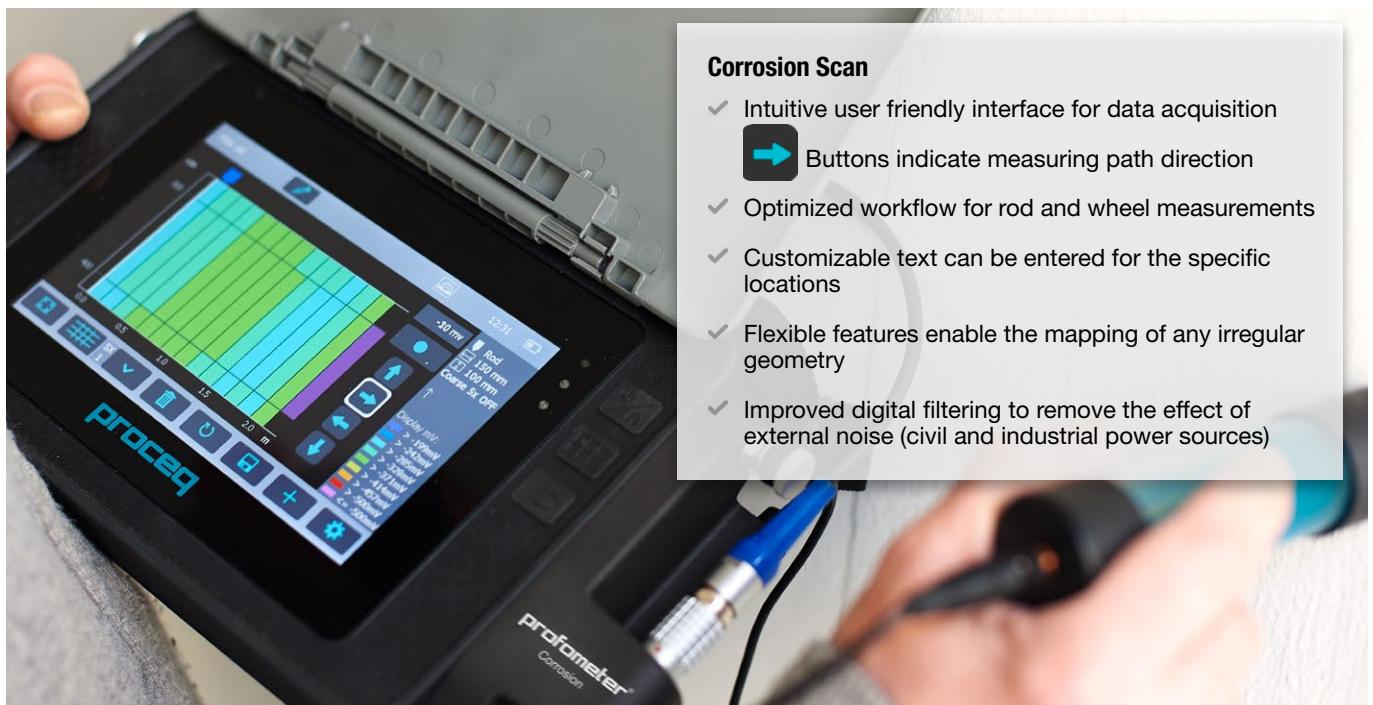

Statistical Views

- ✓ Immediate on site data interpretation
- ✓ Customizable Distribution, Cumulative Distribution, Chipping Graph Views
- ✓ Predefined ASTM compliant layout

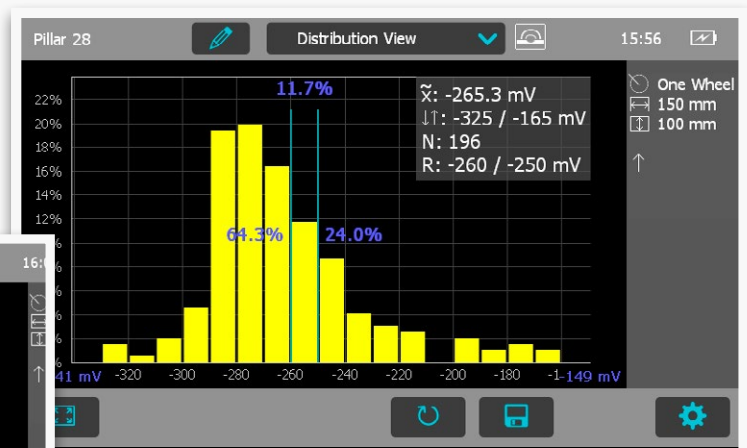
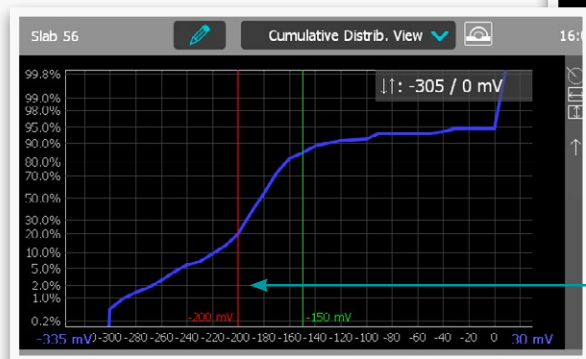

Adjustable cursors defining corrosion thresholds

Profometer® Link PC Tool

Profometer Link - A combined PC tool

Proceq Profometer Link PC tool is included with all Profometer 6 Cover Meter and Profometer Corrosion units. It is based on an integrated suite enabling the user to process the data coming from rebar detection / concrete cover as well as corrosion potential measurement. The Profometer units can be connected to the PC via USB and the software is fully compatible with Windows 7, 8 and 10 (32- and 64-bit).

- ✓ All features available on the touchscreen unit are also implemented on the PC
- ✓ Create custom reports with exported graphs and charts
- ✓ Support for the merging of several corrosion scans into a single graph
- ✓ Picture and table export (csv files) for further processing, combined data evaluation and reporting on any third party software

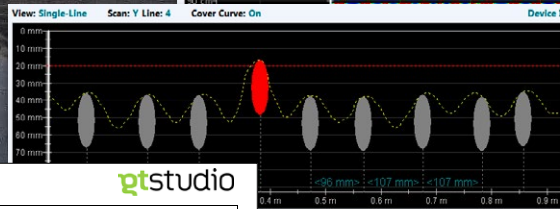
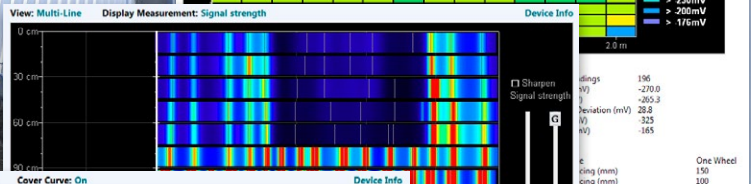
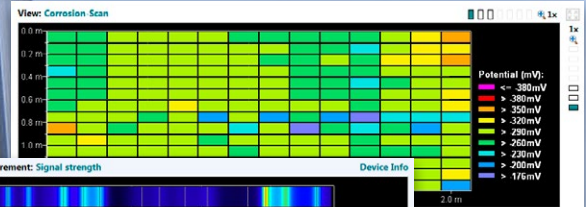

ET051/13 - All.

gtstudio

LOCATION: UG Slab H12

Pic / Graph

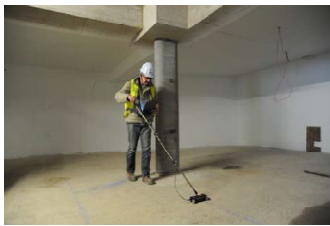

Pic / Graph

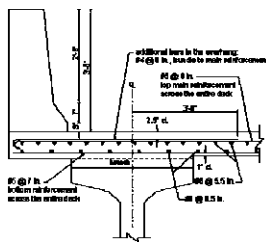

Pic / Graph

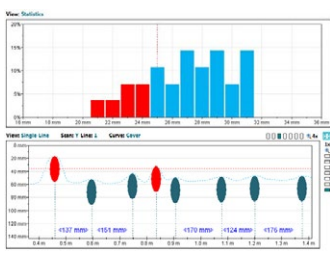

Pic / Graph

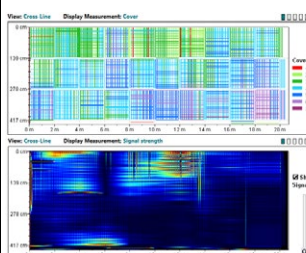

DATA

Snagshots (mm mm mm)	[Distance(m) Cover(mm)]	Statistics of Covers (IRV)
LX1	(2.341 45.1) (3.714 39.7) (5.462 35.9) (8.030 24.8) (10.463 37.6)	Scan Direction [X, Y]
(0.151 25.2) (2.278 41.9) (3.838 48.5) (5.531 35.8) (8.195 24.7)	No. of Readings [67, 298]	Rebar Diameter Scan-X (mm) 20
(9.395 39.6) (2.328 43.7) (3.693 41.5) (5.652 45.3) (8.327 11.2)	Median (mm) [67.7, 57.3]	Rebar Diameter Scan-Y (mm) 20
(9.374 38.0) (2.409 36.5) (3.989 42.3) (5.817 47.8) (8.505 20.4)	Mean (mm) [67.0, 56.9]	Rebar Correction 0
(9.583 40.5) (2.444 35.0) (4.095 40.8) (5.941 52.5) (8.623 28.4)	(Cmm) (%) [0.2, 0.0]	Rebar Spacing Scan-X (cm) 11
(9.764 40.0) (2.557 38.4) (4.099 41.1) (6.108 30.0)	COI% (mm) [10.5, 20.1]	Rebar Spacing Scan-Y (cm) 6
(8.874 40.8) (2.656 44.0) (4.136 37.8) (6.268 37.8)	COI% (mm) [10.8, 11.1]	Minimum Cover 20
(9.892 26.4) (2.729 46.2) (4.209 25.7) (6.411 29.6)	Settings	Minimum Cover Value (mm) 20
(10.008 41.5) (2.858 43.6) (4.527 34.0) (6.520 41.5)	Measuring Range Standard	Maximum Cover 60
(11.212 36.0) (2.963 42.2) (4.628 32.0) (6.752 63.0)	Rebar Diameter Scan-X (mm) 20	Cover Offset 0
(12.887 38.0) (3.090 44.9) (4.699 33.8) (6.866 36.5)	Rebar Diameter Scan-Y (mm) 20	Cover Offset Value (mm) 0
(14.451 38.3) (3.211 44.5) (4.803 34.2) (7.139 52.5)	Rebar Correction 0	Align Rebar Positions 0
(15.849 41.4) (3.381 44.4) (4.879 33.1) (7.304 50.1)	Rebar Spacing Scan-X (cm) 10	Line Height (cm) 20
(17.644 42.0) (3.200 42.9) (4.961 34.4) (7.359 48.5)	Rebar Spacing Scan-Y (cm) 10	Grid Width (cm) 20
(17.740 42.0) (3.313 42.9) (5.020 33.6) (7.571 40.8)	Minimum Cover 20	Probe Position 0
(18.844 42.7) (3.455 39.9) (5.110 31.5) (7.700 35.2)	Maximum Cover 45	
(19.897 39.3) (3.554 42.7) (5.209 30.7) (7.807 47.8)	Cover Offset 0	
(20.007 42.6) (3.678 40.8) (5.328 29.3) (7.903 22.8)	Maximum Cover Value (mm) 60	
	Cover Offset 0	

Technical Specifications

Profometer 6 Cover Meters

Cover measuring range	Up to 185 mm (7.3 inch)
Cover measuring accuracy	± 1 to ± 4 mm (0.04 to 0.16 inch)
Measuring resolution	Depending on diameter and cover
Path measuring accuracy on smooth Surface	± 3 mm (0.12 inch) + 0.5% to 1.0% of measured length
Diameter measuring range	Cover up to 63 mm (2.50 inch), Diameter up to 40 mm (# 12)
Diameter measuring accuracy	± 1 mm (± # 1) on single rebar
Standards and guidelines	BS 1881-204, DIN 1045, DGZfP B2, SN 505262, SS 78-B4, DBV guidelines, CE certification

Profometer Corrosion

Voltage measuring range	-1000 to + 1000 mV
Voltage resolution	1 mV
Impedance	100 MΩ
Sampling rate	900 Hz
Standards and guidelines	ASTM C876*, RILEM TC 154-EMC, DGZfP B3, SIA 2006, UNI 10174, JGJ/T 152, JSCE E 601, CE certification

Profometer Touchscreen Universal

Display	7" colour display 800x480 pixels
Memory	Internal 8 GB flash memory
Regional settings	Metric and imperial units and multi-language and timezone supported
Power input	12 V +/-25 % / 1.5 A
Dimensions	250 x 162 x 62 mm
Weight (of display device)	About 1525 g (incl. battery)
Battery	3.6 V, 14 Ah
Battery lifetime	> 8h (in standard operating mode)
Humidity	< 95 % RH, non condensing
Operating temperature	-10°C to +50°C
IP classification	Touchscreen IP54, universal probe IP67

*Note: for the full ASTM C876 compliance, depending on the maximum aggregate size of the investigated concrete, the user may have to provide a larger contact sponge than the standard one supplied with the rod electrode.

NDT Training on rebar assessment and corrosion analysis

Proceq's training modules are strongly focused on a practical approach to routine testing of in-situ concrete quality, as well as on user specific applications using the Profometer products. Visit our website or contact your Proceq representative.



Ordering Information

Upgrade kits

Cover Meters

Corrosion

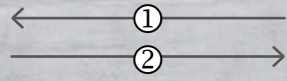

Cover meter

392 10 001

Profometer 600

consisting of Profometer touchscreen, universal probe with probe cart, probe cable 1.5 m (5 ft), power supply, USB cable, chalk, DVD with software, documentation, carrying strap and carrying case



392 50 001

Profometer Corrosion

consisting of Profometer touchscreen, interface box, battery charger, cable coil l=25 m (82 ft) with clamp, USB cable, DVD with software, documentation, carrying strap and carrying case



392 001 15 **Software upgrade** (activation key)

Scan cover meter

392 20 001

Profometer 630

consisting of Profometer touchscreen, universal probe with probe cart, probe cable 1.5 m (5 ft), power supply, USB cable, chalk, DVD with software, documentation, carrying strap and carrying case



Spot checks

Ideal for line and area scans

Scanning areas at 4x speed

392 001 16 **Software upgrade** (activation key)

Cross-scan cover meter

392 30 001

Profometer 650

consisting of Profometer touchscreen, universal probe with probe cart, probe cable 1.5 m (5 ft), power supply, USB cable, chalk, DVD with software, documentation, carrying strap and carrying case



392 50 010

Profometer Corrosion rod electrode

with spare parts, cable and copper sulphate (250 g)



330 01 001

Profometer Corrosion one wheel electrode

with telescopic rod 1.7 m (5.6 ft), encoder, cables, spare parts, tool kit, copper sulphate (250 g), citric acid



330 01 004

Profometer Corrosion four wheel electrode

with telescopic rod 1.7 m (5.6 ft), encoder, cables, spare parts, tool kit, copper sulphate (250 g), citric acid (250 g), carrying case



②

392 50 002

Upgrade kit to Profometer Corrosion

consisting of interface box, cable coil, l=25 m (82 ft) with clamp, DVD with software, documentation and carrying case



Upgrade kits

①

392 50 003

Upgrade kit to Profometer 600 Cover Meter

consisting of universal probe with cart, probe cable 1.50m (5ft), software upgrade to cover meter



Accessories

392 40 040

Profometer 6 telescopic extension rod 1.7 m (5.6 ft) with probe cable 3 m (10 ft)

330 00 322

Profometer Corrosion telescopic extension rod for rod electrode 1.7 m (5.6 ft), with 3 m (10 ft) cable

327 01 033

Spare battery

327 01 053

Quick charger (external) for touchscreen unit

356 00 082

Display antiglare protection film for touchscreen unit

Service and Support

Proceq is committed to providing the best support and service available in the industry through the Proceq certified service centers worldwide. This results in a complete support for the Profometer by means of our global service and support facilities.

Subject to change without notice. All information contained in this documentation is presented in good faith and believed to be correct. Proceq SA makes no warranties and excludes all liability as to the completeness and/or accuracy of the information. For the use and application of any product manufactured and/or sold by Proceq SA explicit reference is made to the particular applicable operating instructions.

Warranty Information

Each instrument is backed by the standard Proceq warranty and extended warranty options.

- » Electronic portion of the instrument: 24 months
- » Mechanical portion of the instrument: 6 months

 Click on the Proceq subsidiaries for more information

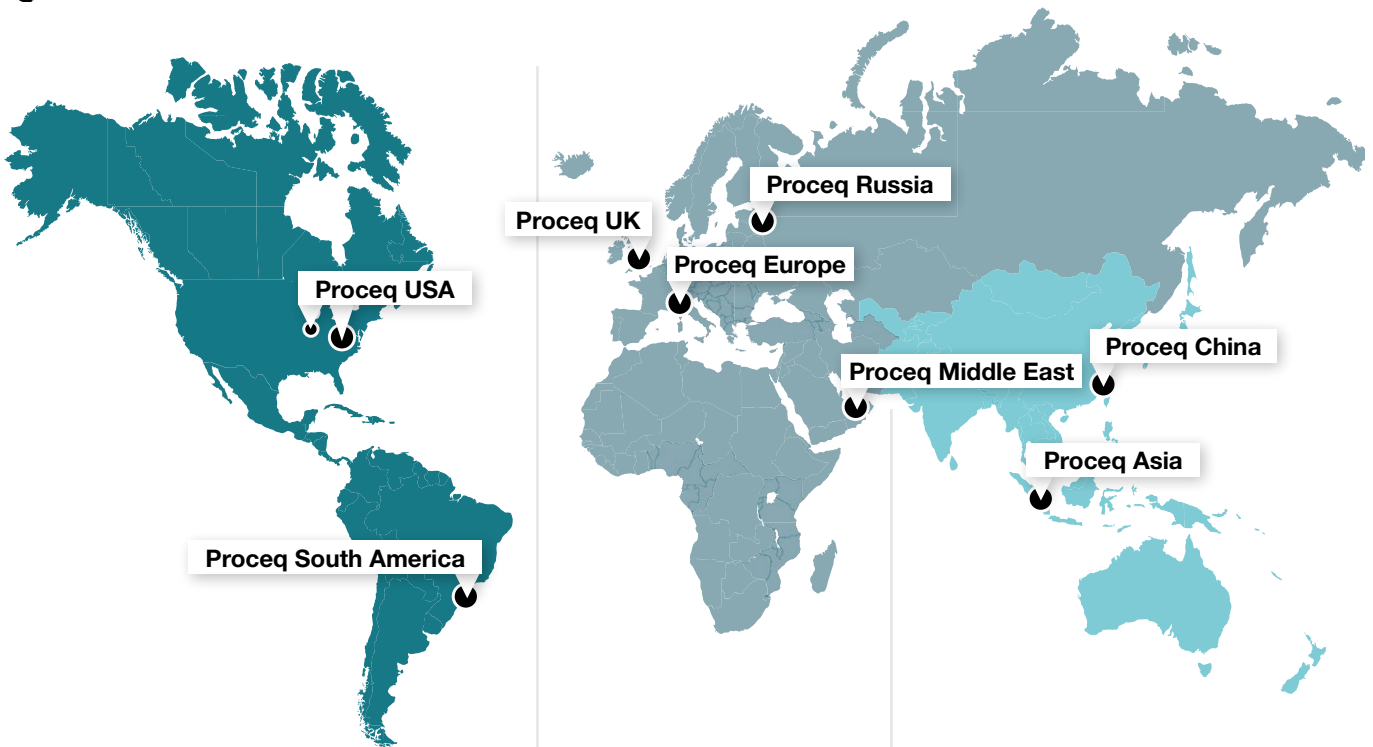

Proceq USA

Aliquippa, PA, USA
Phone +1 724 512 0330
Fax +1 724 512 0331
info-usa@proceq.com

Gurnee, IL, USA
Phone +1 847 623 9570
Fax +1 847 623 9580
info-usa@proceq.com

Proceq South America

São Paulo, Brasil
Phone +55 11 3083 38 89
info-southamerica@proceq.com

Proceq Europe

Schwerzenbach, Switzerland
Phone +41 43 355 38 00
Fax +41 43 355 38 12
info-europe@proceq.com

Proceq UK

Bedford, UK
Phone +44 12 3483 4515
info-uk@proceq.com

Proceq Russia

St. Petersburg, Russia
Phone +7 812 448 35 00
Fax +7 812 448 35 00
info-russia@proceq.com

Proceq Middle East

Sharja, United Arab Emirates
Phone +971 6 557 8505
Fax +971 6 557 8606
info-middleeast@proceq.com

Proceq Asia

Singapore
Phone +65 6382 3966
Fax +65 6382 3307
info-asia@proceq.com

Proceq China

Shanghai, China
Phone +86 21 63177479
Fax +86 21 63175015
info-china@proceq.com



 E-Shop USA

 E-Shop Europe

 E-Shop Asia



Globally organized seminars to help you learn more about our products and applications.
Contact your local representative for further information.

Proceq SA

Ringstrasse 2
8603 Schwerzenbach
Switzerland

81039201E ver 03 2016 © Proceq SA, Switzerland. All rights reserved.

